	GLOBAL STANDARD	Page 1 of 22
	AUTOMATIC FOUR-POLE CIRCUIT-BREAKERS WITH 40 A ÷ 630 A RATED CURRENT FOR SECONDARY SUBSTATIONS	<b>GSCL003</b> Rev. 0 20/06/2016

## AUTOMATIC FOUR-POLE CIRCUIT-BREAKERS WITH 40 A ÷ 630 A RATED CURRENT FOR SECONDARY SUBSTATIONS

Countries' I&N	Elaborated by
Iberia	<b>J. Gonzalez</b>
Italy	<b>M. Neri</b>
Romania	<b>V. Obrejan</b>

	Elaborated by	Verified by	Approved by
<b>Solution Development Center</b>	<b>M. Neri</b>	<b>L. Giansante</b>	<b>I. Gentilini</b>
<b>Global I&amp;N – NT/NCS</b>	-	<b>N. Cammalleri G. Egea Brufau</b>	<b>F. Giammanco</b>

Revision	Type of modification
00	First edition –

This document is intellectual property of Enel Spa; reproduction or distribution of its contents in any way or by any means whatsoever is subject to the prior approval of the above mentioned company which will safeguard its rights under the civil and penal codes.  
This document is for Internal Use.

	GLOBAL STANDARD	Page 2 of 22
	<b>AUTOMATIC FOUR-POLE CIRCUIT-BREAKERS WITH 40 A ÷ 630 A RATED CURRENT FOR SECONDARY SUBSTATIONS</b>	<b>GSCL003</b> Rev. 0 20/06/2016

## INDEX

<b>1. SCOPE</b>	<b>3</b>
<b>2. FIELD OF APPLICATION</b>	<b>3</b>
<b>3. COMPONENT IDENTIFICATION</b>	<b>3</b>
<b>4. REFERENCE LAWS AND STANDARDS</b>	<b>3</b>
<b>5. IDENTIFICATION COMPONENTS</b>	<b>5</b>
<b>6. UNIT MEASUREMENT</b>	<b>7</b>
<b>7. IDENTIFICATION COMPONENTS</b>	<b>8</b>
<b>8. TECHNICAL SPECIFICATIONS</b>	<b>8</b>
<b>9. CONSTRUCTION CHARACTERISTICS</b>	<b>14</b>
<b>10. SUPPLY REQUIREMENTS</b>	<b>21</b>

	GLOBAL STANDARD	Page 3 of 22
	AUTOMATIC FOUR-POLE CIRCUIT-BREAKERS WITH 40 A ÷ 630 A RATED CURRENT FOR SECONDARY SUBSTATIONS	<b>GSCL003</b> Rev. 0 20/06/2016

## 1. SCOPE

The scope of this document is to provide the technical requirements for the supply of automatic circuit-breakers for use in Low Voltage distribution networks with rated currents of 40 A - 80 A – 120 A – 180 A - 250 A (with 10 kA pole mounted transformers and 25 kA for substations rated short-circuit breaking capacities) – 350 A and 630 A (with 25 kA rated short-circuit breaking capacities) of the Enel Group Distribution companies listed below:

- Endesa Distribución Eléctrica (Spain)
- Enel Distribuție Banat (Romania)
- Enel Distribuție Dobrogea (Romania)
- Enel Distribuție Muntenia (Romania)
- Enel Distribuzione (Italy)

Some requirements are applicable only to one or more companies. Therefore, depending on the destination, the supplied equipment shall comply with these specific requirements.

## 2. FIELD OF APPLICATION

These requirements apply to automatic four-pole circuit-breakers used in Low Voltage distribution networks and installed in secondary substations and pole-mounted transformers (PMT).

The document is used in purchase tenders and for conformity and quality technical checks.

## 3. COMPONENT IDENTIFICATION

This specification refers to the family of four-pole circuit-breakers with rated current from 40 A to 630 A for secondary substations identified as follows:

## 4. REFERENCE LAWS AND STANDARDS

### 4.1 Laws

#### 4.1.1 Italy – Romania - Spain

- Directive 2006/95/EC of the European Parliament and of the Council of 12 December 2006.
- Directive 2004/108/EC electromagnetic compatibility.
- Directive 2014/30/UE of the European Parliament - 26.2.14.

	GLOBAL STANDARD	Page 4 of 22
	AUTOMATIC FOUR-POLE CIRCUIT-BREAKERS WITH 40 A ÷ 630 A RATED CURRENT FOR SECONDARY SUBSTATIONS	<b>GSCL003</b> Rev. 0 20/06/2016

#### **4.1.2 Italy**

- D.Lgs n. 81 of the 9th of April 2008 and subsequent modifications.
- Decreto Ministeriale Ambiente n. 20 – 25 Gen. 2011

#### **4.1.3 Romania**

- Legea securității și sănătății în muncă nr.319/2006, cu modificările și completările ulterioare.
- Ordonanța de Urgență nr. 195/22.12.2005 privind protecția mediului, cu toate modificările și completările în vigoare.
- Legea nr. 211/25.11.2011 privind regimul deșeurilor.
- H.G. 856/2002 privind evidența gestiunii deșeurilor și pentru aprobarea listei cuprinzând deșeurile, inclusiv deșeurile periculoase, completată de HG 210/2007.
- H.G. 1037/03.11.2010 privind deșeurile de echipamente electrice și electronice.
- H.G. nr. 1132/18.09.2008 privind regimul bateriilor și acumulatorilor și al deșeurilor de baterii și acumulatori.

#### **4.1.4 Spain**

- R.D. 337/2014, de 9 de mayo, por el que se aprueban el Reglamento sobre condiciones técnicas y garantías de seguridad en instalaciones eléctricas de alta tensión y sus Instrucciones Técnicas Complementarias ITC-RAT 01 a 23.
- R.D. 614/2001, de 8 de junio, sobre disposiciones mínimas para la protección de la salud y seguridad de los trabajadores frente al riesgo eléctrico.
- Real Decreto 842/2002, de 2 de agosto, por el que se aprueba el Reglamento Electrotécnico para Baja Tensión, con sus instrucciones técnicas complementarias

## **4.2 Standards**

### **4.2.1 Common standards**

The below listed reference documents shall be intended in the in-force edition at the contract date (amendments included). Unless otherwise specified, these documents are valid until the new editions replace them.

For Latin America destinations the reference standards are the IEC/ISO, whilst for Europe destinations the reference standards are the correspondent European ones (EN).

	GLOBAL STANDARD	Page 5 of 22
	AUTOMATIC FOUR-POLE CIRCUIT-BREAKERS WITH 40 A ÷ 630 A RATED CURRENT FOR SECONDARY SUBSTATIONS	<b>GSCLO03</b> Rev. 0 20/06/2016

Standards	Edition
EN 60947-2	2006-08
EN 60947-1	2007-07

#### 4.2.2 Specific standards

Unless otherwise specified, these standards are valid until the new editions replace them.

##### 4.2.2.1 Enel Distribuzione

Standards	Revision
DY3501	6
DY1053	2
DY818	4
GSCB003	0
DY3018	3
DY3023	3
EA0210	4
EA0211	5
EA0037	6
PVR001	2
PVR006 + alleg. alla N.O. PVR006	2
Packaging, transport and delivery requirements	2

## 5. IDENTIFICATION COMPONENTS

This specification refers to the family of four-pole circuit-breakers with rated current from 40 A to 630 A for secondary substations identified as follows:

	GLOBAL STANDARD	Page 6 of 22
	AUTOMATIC FOUR-POLE CIRCUIT-BREAKERS WITH 40 A ÷ 630 A RATED CURRENT FOR SECONDARY SUBSTATIONS	<b>GSCL003</b> Rev. 0 20/06/2016

<b>MANUAL OPERATING CIRCUIT-BREAKERS with VDS</b>							
NUMBER COMPONENTS	G.S. MCCB	DESCRIPTIVE ABBREVIATION	NEUTRAL	I <sub>U</sub> (A)	I <sub>CS</sub> (KA)	REFERENCE CHARACTERISTICS	MAIN USE
GSCL003/01	3101/22	250/S/25	DISCONNECTABLE	250	25	A	SECONDARY SUBSTATIONS
GSCL003/02	3101/23	180/S/25		180		B	
GSCL003/03	3101/24	125/S/25		125		C	
GSCL003/04	3101/25	125/S/10		125	10	D	POLE MOUNTED TRANSFORMERS
GSCL003/05	3101/26	80/S/10		80		E	
GSCL003/06	3101/27	40/S/10		40		F	
GSCL003/07	3101/28	250/C/25	UNINTERRUPTED	250	25	A	SECONDARY SUBSTATIONS
GSCL003/08	3101/29	180/C/25		180		B	
GSCL003/09	3101/30	125/C/25		125		C	
GSCL003/10	3101/31	125/C/10		125	10	D	POLE MOUNTED TRANSFORMERS
GSCL003/11	3101/32	80/C/10		80		E	
GSCL003/12	3101/33	40/C/10		40		F	
GSCL003/13	3101/34	180/S/10	DISCONNECTABLE	180	10	G	POLE MOUNTED TRANSFORMERS
GSCL003/14	3101/35	180/C/10	UNINTERRUPTED	180		G	
GSCL003/15	3102/7	350/S/25	DISCONNECTABLE	350	25	-	SECONDARY SUBSTATIONS
GSCL003/16	3102/8	350/C/25	UNINTERRUPTED	350		-	
GSCL003/17	3103/3	630/S/25	DISCONNECTABLE	630	25	-	SECONDARY SUBSTATIONS
GSCL003/18	3103/4	630/C/25	UNINTERRUPTED	630		-	
<b>MOTOR-DRIVEN CIRCUIT-BREAKERS with VDS</b>							
NUMBER COMPONENTS	G.S. MCCB	DESCRIPTIVE ABBREVIATION	NEUTRAL	I <sub>U</sub> (A)	I <sub>CS</sub> (KA)	REFERENCE CHARACTERISTICS	MAIN USE
GSCL003/19	3101/36	250/S/25/M	DISCONNECTABLE	250	25	A	SECONDARY SUBSTATIONS
GSCL003/20	3101/37	125/S/25/M		125		C	
GSCL003/21	3101/38	250/C/25/M	UNINTERRUPTED	250		A	
GSCL003/22	3101/39	125/C/25/M		125		C	
GSCL003/23	3102/09	350/S/25/M	DISCONNECTABLE	350	25	-	SECONDARY SUBSTATIONS
GSCL003/24	3102/10	350/C/25/M	UNINTERRUPTED	350		-	

By way of example, please note that the descriptive abbreviation 250/S/25 stands for a 250 A disconnectable neutral circuit-breaker with 25 kA rated short-circuit breaking capacity, while the abbreviation 80/C/10 stands for an 80 A uninterrupted neutral circuit-breaker with 10 kA rated short-circuit breaking capacity.

These circuit-breakers can be grouped into two distinct families, based on the location of their installation and on the I<sub>cs</sub> value; the first one is for circuit-breakers installed in secondary substations (using Low Voltage assemblies according to GSCL002 – Fig. 1a):

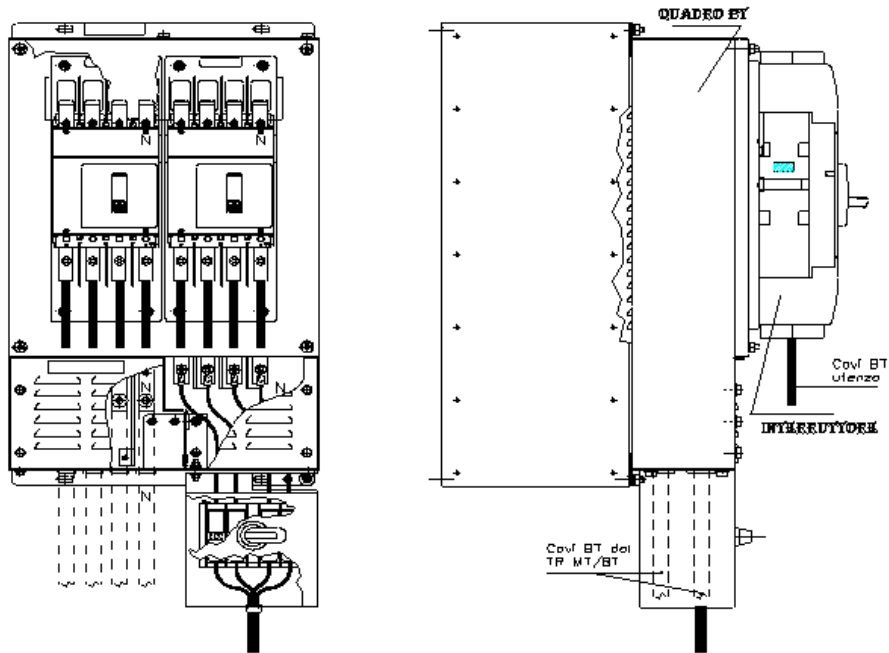

**Figure 1a**

and the second one is for circuit-breakers on Pole Mounted Transformers (using type UE DY3018 – Fig. 1b or type DY3023):

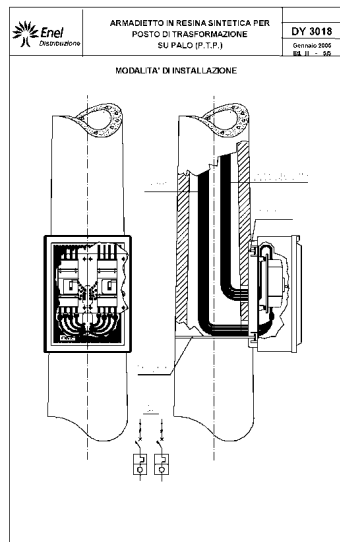

**Figure 1b**

## 6. UNIT MEASUREMENT

The circuit-breakers of this specification are managed as single units (i.e. as numbers). The following is an example of a circuit-breaker description used in ENEL:

I	N	T	E	R	R	U	T	T	O	R	E	A	U	T	O	M	A	T	B	T	4	P	2	5	0	/	C	/	2	5	U	E
---	---	---	---	---	---	---	---	---	---	---	---	---	---	---	---	---	---	---	---	---	---	---	---	---	---	---	---	---	---	---	---	---

	GLOBAL STANDARD	Page 8 of 22
	AUTOMATIC FOUR-POLE CIRCUIT-BREAKERS WITH 40 A ÷ 630 A RATED CURRENT FOR SECONDARY SUBSTATIONS	<b>GSCL003</b> Rev. 0 20/06/2016

## 7. IDENTIFICATION COMPONENTS

Serial Number	Italy	Romania	Iberia
Serial Components	Enel Distribuz.	Enel Distributie	Endesa distribucion
GSCL003/01	13 11 02	---	6712126
GSCL003/02	13 11 03	---	6712125
GSCL003/03	13 11 04	---	6712124
GSCL003/04	13 11 05	---	---
GSCL003/05	13 11 06	---	---
GSCL003/06	13 11 07	---	---
GSCL003/07	13 11 08	13 11 08	6712131
GSCL003/08	13 11 09	13 11 09	6712130
GSCL003/09	13 11 10	13 11 10	6712129
GSCL003/10	13 11 11	13 11 11	---
GSCL003/11	13 11 12	13 11 12	---
GSCL003/12	13 11 13	13 11 13	---
GSCL003/13	13 11 14	---	---
GSCL003/14	13 11 15	13 11 15	---
GSCL003/15	13 11 20	---	6712127
GSCL003/16	13 11 21	13 11 21	6712132
GSCL003/17	13 11 24	---	6712128
GSCL003/18	13 11 25	13 11 25	6712133
GSCL003/19	13 11 16	---	6712135
GSCL003/20	13 11 17	---	6712134
GSCL003/21	13 11 18	13 11 18	6712138
GSCL003/22	13 11 19	13 11 19	6712137
GSCL003/23	13 11 22	---	6712136
GSCL003/24	13 11 23	13 11 23	6712139

## 8. TECHNICAL SPECIFICATIONS

The circuit-breakers of this specification must observe the general requirements and the regulations enforced by the reference documents in chapter 4.

In general, once installed the circuit breakers on the switchboard, and placed the terminal covers, the insulation level between the active parts (phases and neutral) and earth (considering earth also any point on the outside surface of the circuit breaker envelope) must be equal or greater than 10kV (1 minute).

The tables below reports the specific requirements that the individual circuit-breakers must observe according to their size and installation characteristics.



	GLOBAL STANDARD	Page 9 of 22
	AUTOMATIC FOUR-POLE CIRCUIT-BREAKERS WITH 40 A ÷ 630 A RATED CURRENT FOR SECONDARY SUBSTATIONS	<b>GSCL003</b> Rev. 0 20/06/2016

## 8.1 Characteristics of circuit-breaker with 40 - 250 A rated current

CHARACTERISTICS	REFERENCE	REFERENCE						
		A	B	C	D	E	F	G
Circuit-breaker type		four-pole, suitable for isolation, moulded case type with organic material enclosure without accessible metallic parts, maintenance free						
Installation type		vertical						
IP code <sup>(1)</sup>		IP3X <sup>(2)</sup>						
Frequency (Hz)		50						
Making operating system		independent manual with non-removable lever						
Breaking operating system		independent manual with non-removable lever and with thermal and magnetic releases						
Rated voltage (U <sub>e</sub> ) (V)		400						
Rated insulation voltage (U <sub>i</sub> ) (V)		690						
Rated impulse withstand voltage (U <sub>imp</sub> ) (kV)		8						
Rated uninterrupted current at 40 °C (I <sub>n</sub> ) (A)		250	180	125	125	80	40	180
Service		uninterrupted						
Utilization category		A						
Rated service short-circuit breaking capacity (I <sub>cs</sub> ) (kA)		25			10			
Phase thermal release (1 per phase) <sup>(3)</sup>								
- conventional free air thermal current at 40 °C (I <sub>th</sub> ) (A)		250	180	125	125	80	40	180
- conventional non tripping current (A)		1.05 I <sub>th</sub>						
- conventional tripping current (A)		1.30 I <sub>th</sub>						
- maximum breaking time at 2 I <sub>th</sub> on single pole with cool release at ambient temperature of 40 °C (min)		12	10	8	8	8	6	10
Phase magnetic release (1 per phase) <sup>(3)</sup>								
- current setting (I <sub>m</sub> ) (A)		1250	1000	800	800	400	200	1000
- breaking time for a tripping current of 3 I <sub>m</sub> (ms)		≤ 15						
- tripping current precision (%)		± 20						
Neutral thermal release <sup>(3)</sup>								
- conventional free air thermal current at 40 °C (I <sub>th</sub> ) (A)		125	100	80	80	-	-	100
- conventional non tripping current (A)		1.05 I <sub>th</sub>				-	-	1.05 I <sub>th</sub>
- conventional tripping current (A)		1.30 I <sub>th</sub>				-	-	1.30 I <sub>th</sub>
- maximum breaking time at 2 I <sub>th</sub> on single pole with cool release at ambient temperature of 40 °C (min)		8				-	-	8
Neutral magnetic release <sup>(3)</sup>								
- current setting (I <sub>m</sub> ) (A)		800	600	500	400	-	-	600
- breaking time for a tripping current of 3 I <sub>m</sub> (ms)		≤ 15				-	-	≤ 15
- tripping current precision (%)		± 20				-	-	± 20
Ambient temperature								
- upper limit (°C)		40						
- lower limit (°C)		-20			-25			
Temperature-rise limit of terminals (K)		60						
Nominal tightening torque of terminals (Nm)		15	10	8	8	8	6	10

(1) EXCEPT FOR THE BACK SIDE OF THE CIRCUIT-BREAKER.

(2) EXCEPT FOR TERMINAL COVERINGS (LOAD CABLE SIDE) FOR WHICH THE IP2X DEGREE OF PROTECTION IS REQUIRED.

(3) NOT ADJUSTABLE.

	GLOBAL STANDARD		Page 10 of 22
	AUTOMATIC FOUR-POLE CIRCUIT-BREAKERS WITH 40 A ÷ 630 A RATED CURRENT FOR SECONDARY SUBSTATIONS		<b>GSCL003</b> Rev. 0 20/06/2016

The circuit-breaker terminals, required for clamping cables, must be capable of clamping the cable conductors listed in the table below:

CIRCUIT-BREAKER TYPE	GSCL003/01-07-19-21		GSCL003/02-08-13-14		GSCL003/03-09-20-22		GSCL003/04-05-06-10-11-12	
	CU	AL	CU	AL	CU	AL	CU	AL
CABLE FORMATION AND GROUP ENEL REFERENCE SPECIFICATION	3X95+50	3X150+95 DC4146 NCDC4147	3X50+25	3X95+35 DC4126	3X25+25 3X50+25	3X70+54,6 DC4182	3X16+16 <sup>(4)</sup> 3X25+25 3X50+25	3X35+54,6 3X70+54,6
	DC4122	3X150+95 GSC002  3X150+80 BNL001	DC4122	3X70+54,6 DC4182  3X95 + 50 GSC002  3X95+54,6 BNL001	DC4122	3X50+50 GSC002  3X50+54,6 BNL001	DC4122	DC4182

(4) ONLY FOR GSCL003/06 AND GSCL003/12

	GLOBAL STANDARD	Page 11 of 22
	AUTOMATIC FOUR-POLE CIRCUIT-BREAKERS WITH 40 A ÷ 630 A RATED CURRENT FOR SECONDARY SUBSTATIONS	<b>GSCL003</b> Rev. 0 20/06/2016

## 8.2 Characteristics of circuit-breaker with 350 A rated current

CHARACTERISTICS		
Circuit-breaker type		four-pole, suitable for isolation, moulded case type with organic material enclosure without accessible metallic parts, maintenance free
Installation type		vertical
IP code <sup>(5)</sup>		IP3X <sup>(6)</sup>
Frequency (Hz)		50
Making operating system		independent manual with non-removable lever
Breaking operating system		independent manual with non-removable lever and with thermal and magnetic releases
Rated voltage (U <sub>e</sub> ) (V)		400
Rated insulation voltage (U <sub>i</sub> ) (V)		690
Rated impulse withstand voltage (U <sub>imp</sub> ) (kV)		8
Rated uninterrupted current at 40 °C (I <sub>n</sub> ) (A)		350
Service		uninterrupted
Utilization category		A
Rated service short-circuit breaking capacity (I <sub>cs</sub> ) (kA)		25
<u>Phase thermal release (1 per phase)<sup>(7)</sup></u>		
- conventional free air thermal current at 40 °C (I <sub>th</sub> ) (A)		280 ÷ 350
- conventional non tripping current (A)		1.05 I <sub>th</sub>
- conventional tripping current (A)		1.30 I <sub>th</sub>
- maximum breaking time at 2 I <sub>th</sub> on single pole with cool release at ambient temperature of 40 °C (min)		12
<u>Phase magnetic release (1 per phase)</u>		
- current setting (I <sub>m</sub> ) (A)		1750
- breaking time for a tripping current of 3 I <sub>m</sub> (ms)		≤ 15
- tripping current precision (%)		± 20
<u>Neutral thermal release<sup>(7)</sup></u>		
- conventional free air thermal current at 40 °C (I <sub>th</sub> ) (A)		140 ÷ 175
- conventional non tripping current (A)		1.05 I <sub>th</sub>
- conventional tripping current (A)		1.30 I <sub>th</sub>
- maximum breaking time at 2 I <sub>th</sub> on single pole with cool release at ambient temperature of 40 °C (min)		12
<u>Neutral magnetic release</u>		
- current setting (I <sub>m</sub> ) (A)		1000
- breaking time for a tripping current of 3 I <sub>m</sub> (ms)		≤ 15
- tripping current precision (%)		± 20
<u>Ambient temperature</u>		
- upper limit (°C)		40
- lower limit (°C)		-20
<u>Temperature-rise limit of terminals (at I<sub>th</sub> = 350 A)</u> (K)		60
<u>Nominal tightening torque of terminals</u> (Nm)		20

(5) EXCEPT FOR THE BACK SIDE OF THE DEVICE

(6) EXCEPT FOR THE TERMINAL COVERINGS (LOAD CABLE SIDE) FOR WHICH THE IP2X DEGREE OF PROTECTION IS REQUIRED

(7) ADJUSTABLE FROM 0.8 TO 1 I<sub>TH</sub> (FACTORY DEFAULT VALUE SET AT 1 I<sub>TH</sub>).

	GLOBAL STANDARD		Page 12 of 22
	<b>AUTOMATIC FOUR-POLE CIRCUIT-BREAKERS WITH 40 A ÷ 630 A RATED CURRENT FOR SECONDARY SUBSTATIONS</b>		<b>GSCL003</b> Rev. 0 20/06/2016

The lower terminals of the circuit-breakers must be capable of clamping the cable conductors listed in the table below:

CIRCUIT-BREAKER TYPE	GSCL003/15-16-23-24	
CONDUCTOR MATERIAL	CU	AL
CABLE FORMATION AND ENEL REFERENCE SPECIFICATION	3X150+95  DC4122	3X240+95 DC4126  3X240+150 DC4146  3X240+150 GSC002

	GLOBAL STANDARD	Page 13 of 22
	AUTOMATIC FOUR-POLE CIRCUIT-BREAKERS WITH 40 A ÷ 630 A RATED CURRENT FOR SECONDARY SUBSTATIONS	<b>GSCL003</b> Rev. 0 20/06/2016

### 8.3 Characteristics of circuit-breaker with 630 A rated current

CHARACTERISTICS		
Circuit-breaker type		four-pole, suitable for isolation, moulded case type with organic material enclosure without accessible metallic parts, maintenance free
Installation type		vertical
IP code <sup>(8)</sup>		IP3X <sup>(9)</sup>
Frequency (Hz)		50
Making operating system		independent manual with non-removable lever
Breaking operating system		independent manual with non-removable lever and with thermal and magnetic releases
Rated voltage (U <sub>e</sub> ) (V)		400
Rated insulation voltage (U <sub>i</sub> ) (V)		690
Rated impulse withstand voltage (U <sub>imp</sub> ) (kV)		8
Rated uninterrupted current at 40 °C (I <sub>n</sub> ) (A)		630
Service		uninterrupted
Utilization category		A
Rated service short-circuit breaking capacity (I <sub>cs</sub> ) (kA)		25
<u>Phase thermal release (1 per phase)<sup>(10)</sup></u>		
- conventional free air thermal current at 40 °C (I <sub>th</sub> ) (A)		504 ÷ 630
- conventional non tripping current (A)		1.05 I <sub>th</sub>
- conventional tripping current (A)		1.30 I <sub>th</sub>
- maximum breaking time at 2 I <sub>th</sub> on single pole with cool release at ambient temperature of 40 °C (min)		12
<u>Phase magnetic release (1 per phase)</u>		
- current setting (I <sub>m</sub> ) (A)		5 I <sub>th</sub> phase
- breaking time for a tripping current of 3 I <sub>m</sub> (ms)		≤ 15
- tripping current precision (%)		± 20
<u>Neutral thermal release<sup>(10)</sup></u>		
- conventional free air thermal current at 40 °C (I <sub>th</sub> ) (A)		256 ÷ 320
- conventional non tripping current (A)		1.05 I <sub>th</sub>
- conventional tripping current (A)		1.30 I <sub>th</sub>
- maximum breaking time at 2 I <sub>th</sub> on single pole with cool release at ambient temperature of 40 °C (min)		12
<u>Neutral magnetic release</u>		
- current setting (I <sub>m</sub> ) (A)		5 I <sub>th</sub> neutral
- breaking time for a tripping current of 3 I <sub>m</sub> (ms)		≤ 15
- tripping current precision (%)		± 20
<u>Ambient temperature</u>		
- upper limit (°C)		40
- lower limit (°C)		-20
<u>Temperature-rise limit of terminals (at I<sub>th</sub> = 630 A)</u> (K)		60
<u>Nominal tightening torque of terminals</u> (Nm)		24

(8) EXCEPT FOR THE BACK SIDE OF THE DEVICE

(9) EXCEPT FOR THE TERMINAL COVERINGS (LOAD CABLE SIDE) FOR WHICH THE IP2X DEGREE OF PROTECTION IS REQUIRED

(10) ADJUSTABLE FROM 0.8 TO 1 I<sub>TH</sub> (FACTORY DEFAULT VALUE SET AT 1 I<sub>TH</sub>).

The lower terminals of the circuit-breakers must be capable of clamping the cable terminals, using an eyelet attachment, for the cables listed in the table below:

	GLOBAL STANDARD	Page 14 of 22
	AUTOMATIC FOUR-POLE CIRCUIT-BREAKERS WITH 40 A ÷ 630 A RATED CURRENT FOR SECONDARY SUBSTATIONS	<b>GSCL003</b> Rev. 0 20/06/2016

CIRCUIT-BREAKER TYPE	GSCL003/17-18
CONDUCTOR MATERIAL	CU
CABLE FORMATION AND ENEL REFERENCE SPECIFICATION	3 X (2X150) + 150 DC4141

To further clarify, it should be noted that:

- the neutral pole must be placed strictly to the right of the R-S-T phase poles and indelibly marked;
- the term “uninterrupted neutral” means a circuit-breaker with a neutral pole without an opening device, but only fitted (where required) with release coils on the neutral which operate on the simultaneous opening of the phase poles;
- GSCL003/05-06-11-12 (E/F characteristics) circuit-breakers are not fitted with release coils (magnetic or thermal) on the neutral pole.

## 9. CONSTRUCTION CHARACTERISTICS

This section provides the construction details of the two circuit-breaker families with limits on external size, installation assembly interface positions, the materials to be used and the surface coatings of the clamps.

These circuit-breaker characteristics are grouped together and can be seen in the schematic drawings of each of the two aforementioned families with the following requirements:

- the clamping plate must be made of black RAL 8002 or grey RAL 7012 plastic of an appropriate thickness. It must bear the manufacturer’s name (see note 1 in fig. 2, 3, and 4);
- the 4 TC fixing screws of the plate clamping the circuit-breaker to the assembly must not be greater in length than the indications given at point 1 in fig. 2 and fig. 4 and point 2 in fig. 3 respectively;
- the circuit-breaker and components must not exceed the size of the clamping plate;
- terminal covers must be properly fixed to the circuit-breaker or the clamping plate (using screws or fasteners);
- the width of the casing where the assembly connection is located only for circuit-breaker types GSCL003/01-02-03-07-08-09-19-20-21-22 (note 4 in fig. 2 and fig.4);
- the operating lever can be asymmetrical on the right or the left side;

	GLOBAL STANDARD	Page 15 of 22
	<b>AUTOMATIC FOUR-POLE CIRCUIT-BREAKERS WITH 40 A ÷ 630 A RATED CURRENT FOR SECONDARY SUBSTATIONS</b>	<b>GSCL003</b> Rev. 0 20/06/2016

- the position of the 4 openings (optionally one single opening) of the plate is free, but it must allow the connection of the assembly with the circuit-breaker mounted on its clamping plate (only for circuit-breaker types GSCL003/01-02-03-07-08-09-19-20-21-22 (note 7 in fig. 2 and fig.4);
- the clamping screws of the circuit-breaker to the clamping plate must not stick out of rear side of the plate itself;
- the line and load clamp-screws of the circuit-breaker must operate with the insulated spanners in the EA0210 specification for types 3101;
- the line and load clamp-screws of the circuit-breaker must operate with the insulated spanners in the EA0211 specification for types 3102;
- the line and load clamp-screws of the circuit-breaker must operate with the insulated spanners in the EA0037 specification for types 3103;
- the circuit-breakers must be fitted with insulating separators between each terminal fixed on the enclosure of the device in order to guarantee electric insulation between terminals even if their coverings have been removed (note 10 in fig. 2 and fig. 4);
- the bolts made of iron must be protected using electrolytic zinc plating (minimum thickness 12µm);
- each circuit-breaker must have a Barcode to allow it to be traced in the field (see Operational Note PVR 006); it must be placed on the body of the circuit-breaker so that it is still visible when flanked by other circuit-breakers.
- Marking, technical documentation and packaging shall be in the language of the destination country for the circuit-breakers.

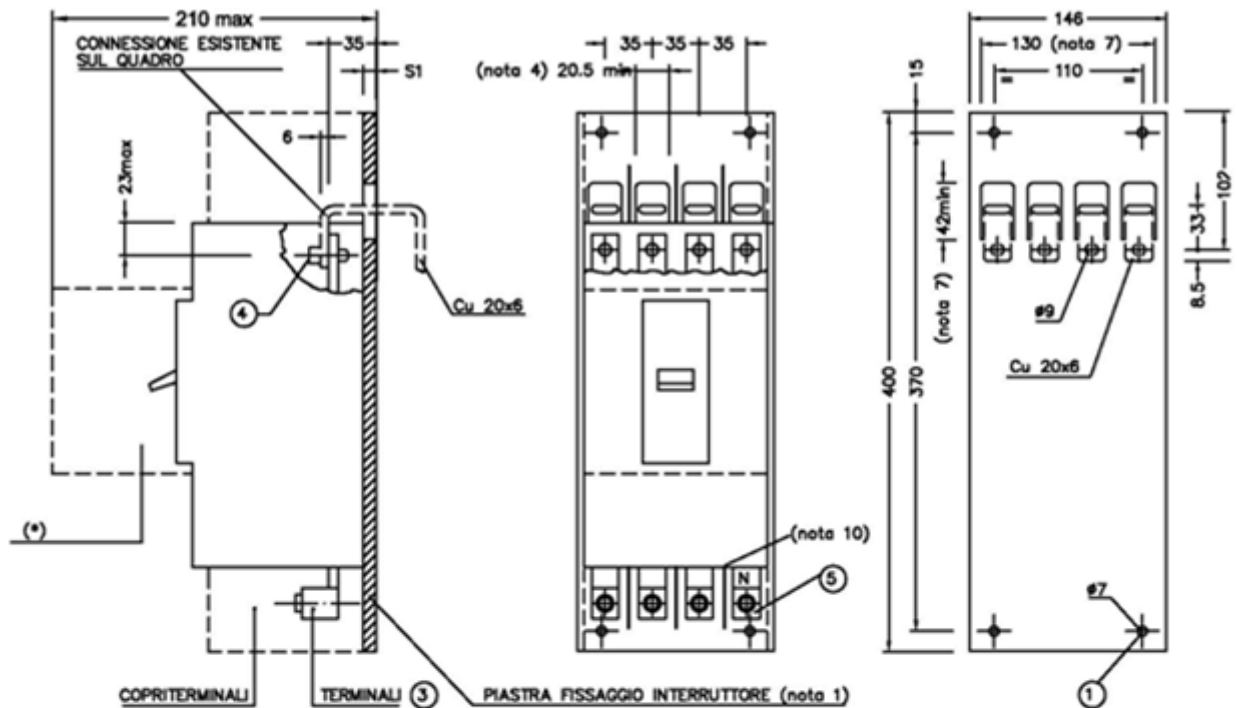
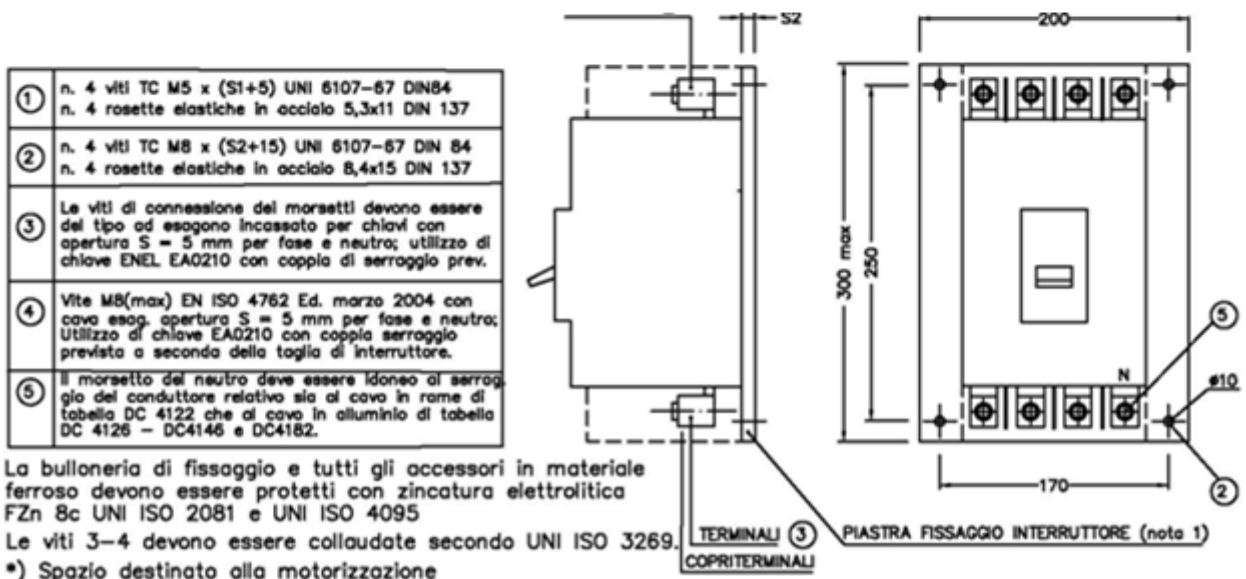
**Fig. 2 - MCCB type DY3101/22-23-24-28-29-30-36-37-38-39 (Sec. Substations)**

**Fig. 3 - MCCB type DY3101/25-26-27-31-32-33-34-35 (Pole mounted transformers)**

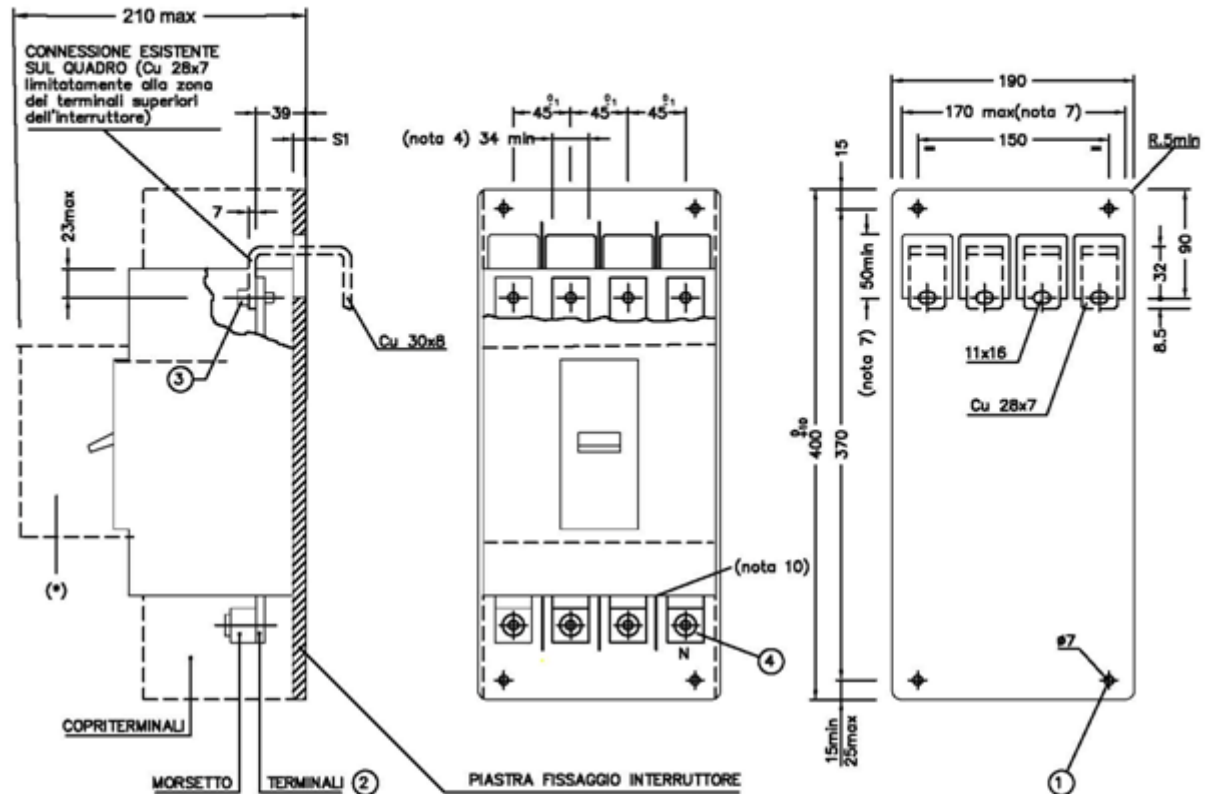

	GLOBAL STANDARD	Page 17 of 22
	AUTOMATIC FOUR-POLE CIRCUIT-BREAKERS WITH 40 A ÷ 630 A RATED CURRENT FOR SECONDARY SUBSTATIONS	<b>GSCL003</b> Rev. 0 20/06/2016

Italian	English
TERMINALI	TERMINALS
COPRITERMINALI	TERMINAL COVERS
PIASTRA FISSAGGIO INTERRUTTORE (nota 1)	CIRCUIT-BREAKER CLAMPING PLATE (note 1)
n. 4 viti TC M5 x (S1+5) UNI 6107-67 DIN84 n. 4 rosette elastiche in acciaio 5,3x11 DIN 137	No. 4 screws TC M5 x (S1+5) UNI 6107-67 DIN84 No. 4 steel spring washers 5.3x11 DIN 137
n. 4 viti TC M8 x (S2+15) UNI 6107-67 DIN84 n. 4 rosette elastiche in acciaio 8,4x15 DIN 137	No. 4 screws TC M8 x (S2+15) UNI 6107-67 DIN84 No. 4 steel spring washers 8.4x15 DIN 137
Le viti di connessione dei morsetti devono essere del tipo ad esagono incassato per chiavi con apertura S = 5 mm per fase e neutro; utilizzo di chiave ENEL EA0210 con coppia di serraggio prev.	Connection clamp screws must be embedded hexagon type for S = 5 mm Allen spanners for phase or neutral; use ENEL EA0210 spanner with the required torque
Vite M8 (max) EN ISO 4762 Ed. marzo 2004 con cava esag. Apertura S = 5 mm per fase e neutro; Utilizzo di chiave EA0210 con coppia serraggio prevista a seconda della taglia di interruttore.	EN ISO 4762 Ed. March 2004 M8 (max) screws with embedded hexagon type for S = 5 mm for phase or neutral; Use EA0210 spanner with the required torque for the size of the circuit-breaker.
Il morsetto del neutro deve essere idoneo al serraggio del conduttore relativo sia al cavo in rame di tabella DC 4122 che al cavo in alluminio di tabella DC 4126 – DC4146 e DC4182	The neutral clamp must be able to tighten the conductor of the copper cable in specifications DC4126, DC4146 and DC4182
La bulloneria di fissaggio e tutti gli accessori in materiale ferroso devono essere protetti con zincatura elettrolitica FeZn 8c UNI ISO 2081 e UNI ISO 4095	The clamping bolts and all iron accessories must be protected using electrolytic zinc plating FeZn 8c UNI ISO 2081 and UNI ISO 4095
Le viti 3-4 devono essere collaudate secondo UNI ISO 3269.	The 3-4 screws must be inspected according to UNI ISO 3269.
*) Spazio destinato alla motorizzazione	*) Space allocated to motor

**Figura 4 - INTERRUTTORI TIPO 3102/7-8-9-10**

①	n. 4 viti TC M5 x (S1+5) UNI 6107-67 DIN84 n. 4 rosette elastiche in acciaio 5,3x11 DIN 137
②	Le viti dei morsetti inferiori devono essere del tipo ad esagono incassato per chiavi con apertura S = 8 mm sia per le fasi che per il neutro tipo Enel EA0211. I terminali inferiori devono essere idonei anche al serraggio del capocorda da fissare con viti M8 (al posto dei morsetti - vedi Part. A).
③	Vite M10 EN ISO 4762:2004 con cava esagonale S = 8 mm; utilizzo chiave tipo Enel EA0211.
④	Il morsetto del neutro deve essere idoneo al serraggio del conduttore in rame 95 mmq relativo sia al cavo in rame di tabella DC 4122 che al cavo in alluminio di tabella DC 4126 e DC 4146.

Note :

La bulloneria di fissaggio e tutti gli accessori in materiale ferroso devono essere protetti con zincatura elettrolitica FZn 8c UNI ISO 2081 e UNI ISO 4095

Le viti (punti 2-3) devono essere collaudate secondo EN ISO 3269:2000

(\*) Spazio destinato alla motorizzazione.

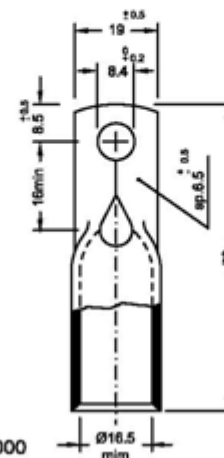
 Part. A  
 CAPOCORDA IN RAME STAGNATO

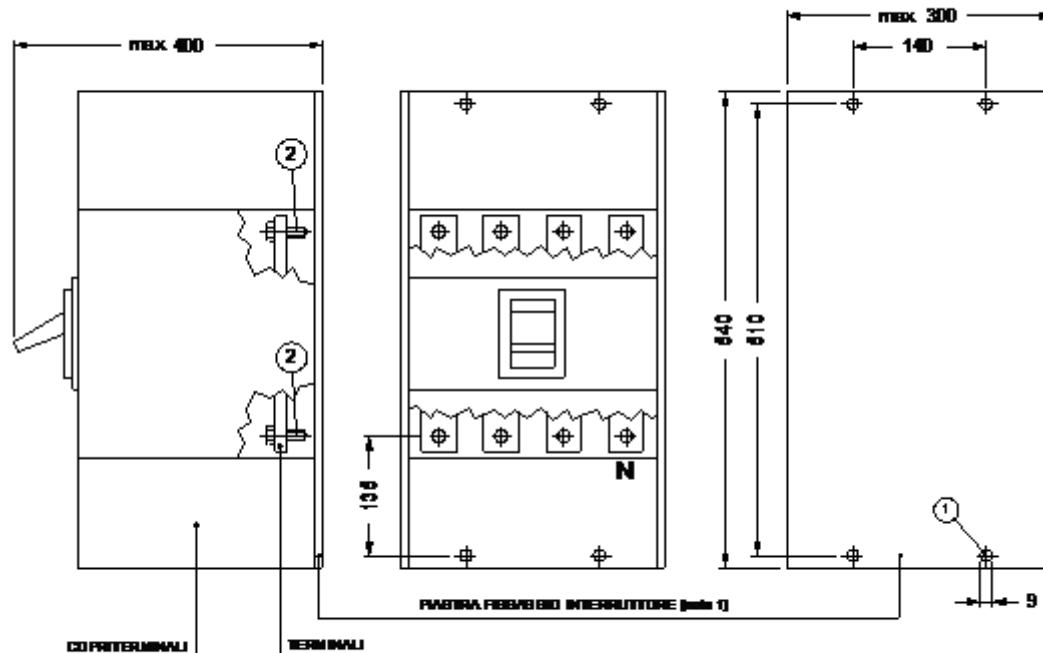

	GLOBAL STANDARD	Page 19 of 22
	AUTOMATIC FOUR-POLE CIRCUIT-BREAKERS WITH 40 A ÷ 630 A RATED CURRENT FOR SECONDARY SUBSTATIONS	<b>GSCL003</b> Rev. 0 20/06/2016

n. 4 viti TC M5 x (S1+5) UNI 6107-67 DIN84 n. 4 rosette elastiche in acciaio 5,3x11 DIN 137	No. 4 screws TC M5 x (S1+5) UNI 6107-67 DIN84 No. 4 steel spring washers 5.3x11 DIN 137
Le viti dei morsetti inferiori devono essere del tipo ad esagono incassato per chiavi con apertura S = 8 mm sia per le fasi che per il neutro tipo ENEL EA0211. I terminali inferiori devono essere idonei anche al serraggio dei capicorda da fissare con viti M8 (al posto dei morsetti – vedi Part. A).	Load clamp screws shall be embedded hexagon type for S = 8 mm Allen spanners for phase or neutral of type ENEL EA0211. Load terminals must be also suitable to clamp cable terminals (see Part. A) using M8 screws (instead of clamps).
Vite M10 EN ISO 4762:2004 con cava esagonale S = 8 mm; utilizzo chiave EA0211.	M10 screws EN ISO 4762:2004 with embedded hexagon type for S = 8 m; use EA0211 spanner.
Il morsetto del neutro deve essere idoneo al serraggio del conduttore in rame 95 mmq relativo sia al cavo in rame di tabella DC 4122 che al cavo in alluminio di tabella DC4126 e DC4146.	The neutral load clamp must be designed to be connected to the copper 95 mm <sup>2</sup> conductor of both copper cable (spec. DC 4122) and aluminium cable (DC4126 and DC4146).
La bulloneria di fissaggio e tutti gli accessori in materiale ferroso devono essere protetti con zincatura elettrolitica FZn 8c UNI ISO 2081 e UNI ISO 4095  Le viti (punti 2-3) devono essere collaudate secondo EN ISO 3269:2000	The clamping bolts and all iron accessories must be protected using electrolytic zinc plating FZn 8c UNI ISO 2081 and UNI ISO 4095  The screws (points 2-3) must be inspected according to EN ISO 3269:2000
(*) Spazio destinato alla motorizzazione	(*) Space allocated to motor

**Figura 5 - INTERRUTTORE TIPO DY3103/3-4**

- ① n° 4 viti M8x25 complete di dadi e rosette (per applicazione su supporto distanziatore)  
 ② Viti M10 oppure M12 con rosette piane ed elastiche, da applicare su capocorda di larghezza massima 31 mm con foro Ø13

Italian	English
TERMINALI	TERMINALS
COPRITERMINALI	TERMINAL COVERS
PIASTRA FISSAGGIO INTERRUTTORE (nota 1)	CIRCUIT-BREAKER CLAMPING PLATE (note 1)
n° 4 viti M8x25 complete di dadi e rosette (per applicazione su supporto distanziatore)	No. 4 M8x25 screws complete with nuts and washers (for application to separator assembly)
Le viti dei morsetti inferiori devono essere del tipo ad esagono incassato per chiavi con apertura S = 8 mm sia per le fasi che per il neutro tipo ENEL EA0211. I terminali inferiori devono essere idonei anche al serraggio dei capicorda da fissare con viti M8 (al posto dei morsetti – vedi Part. A).	Load clamp screws shall be embedded hexagon type for S = 8 mm Allen spanners for phase or neutral of type ENEL EA0211. Load terminals must be also suitable to clamp cable terminals (see Part. A) using M8 screws (instead of clamps).
Viti M10 oppure M12 con rosette piane ed elastiche, da applicare su capocorda di larghezza massima 31 mm con foro Ø13	M10 or M12 screws with spring and flat washers, for application on cable terminals with a maximum width of 31 mm and a Ø13 hole

	GLOBAL STANDARD	Page 21 of 22
	AUTOMATIC FOUR-POLE CIRCUIT-BREAKERS WITH 40 A ÷ 630 A RATED CURRENT FOR SECONDARY SUBSTATIONS	<b>GSCL003</b> Rev. 0 20/06/2016

## 10. SUPPLY REQUIREMENTS

Each circuit-breaker must have its own individual packaging and all the accessories for its correct use, installation and start-up. In particular, each package must contain:

- n. 1 circuit-breaker already mounted to the clamping plate with insulating separators between the terminals and the clamp covers already mounted;
- a bag containing n. 4 screws and n. 4 spring washers for the installation of the circuit-breaker clamping plate onto assembly GSCL002 as indicated at point 1 in fig. 2, 4 and fig. 5; or assembly DY3018 as indicated as point 2 in fig. 3;

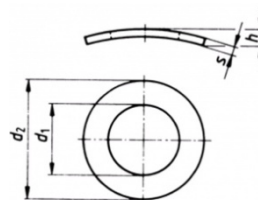
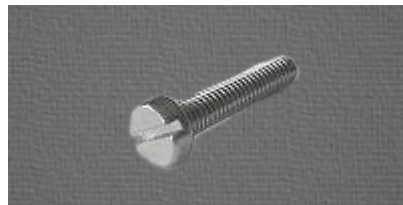

- circuit-breaker start-up instructions (with warnings concerning the installation of insulating separators and clamp covers) and instructions for mounting on GSCL002 assemblies and DY3018 assembly; For MCCB type DY3103 instructions for wall mounting.
- Circuit-breaker maintenance manual and warnings.

A label with the following minimum information must be put on each single package:

- Supplier name
- Circuit-breaker model name
- Enel serial number
- Individual package gross weight

Before shipping products to ENEL deposits, the tasks listed in Monitoring Operational Note Vendor Rating PVR006 must be performed for each circuit-breaker with a serial number.

The requirements regarding dimensions for delivery to ENEL deposits are reported in Packaging, transport and delivery requirements (multiple packaging – Fig. 6). In addition, pallets marked EPAL\_EUR (Fig. 7 – Pallet – Technical specifications) must be used to ensure the observance of Phytosanitary regulations operating in the European Community for the exchange of goods and the load requirements required by Packaging, transport and delivery requirements.

	GLOBAL STANDARD	Page 22 of 22
	AUTOMATIC FOUR-POLE CIRCUIT-BREAKERS WITH 40 A ÷ 630 A RATED CURRENT FOR SECONDARY SUBSTATIONS	<b>GSCL003</b> Rev. 0 20/06/2016

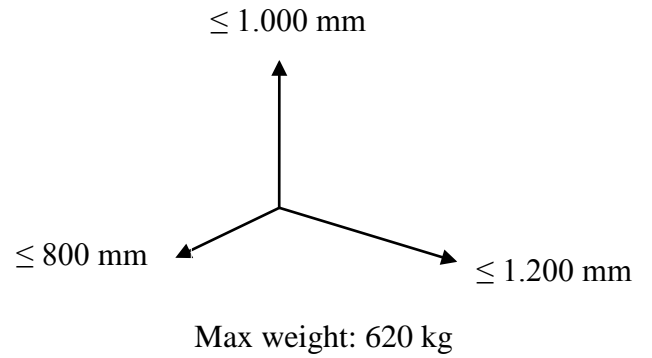

**Figure 6: Multiple packaging**

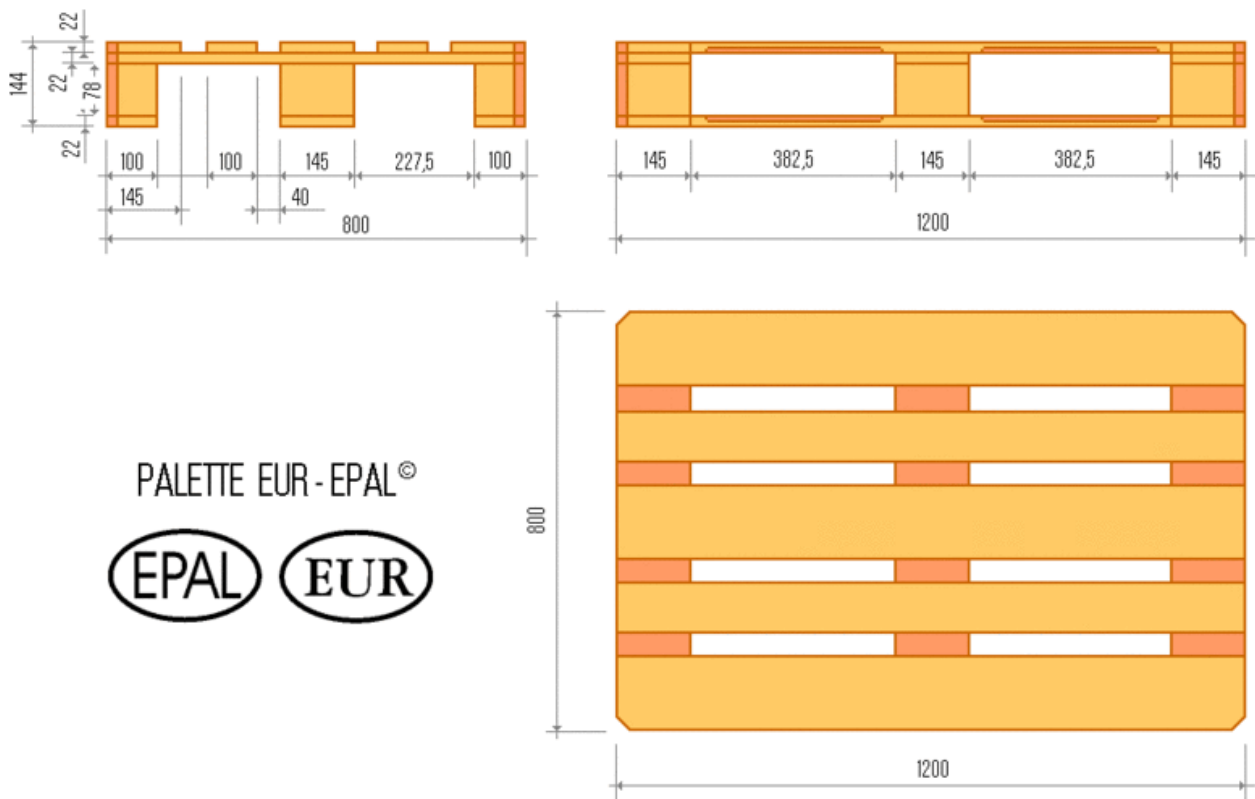

**Figure 7: Pallet – Technical specifications**